

PROJECT	_____
TYPE	_____
SPECIFIER	_____
QUANTITY	_____
DATE	_____

## DAU SINGLE TRACK

### D96048R9-

base number Finish  
Options

- To build a product code in our configurator select the specify button on the base model # product page
- To build a manual product code on this datasheet choose from the options listed below in blue font and add the suffix to the base model #

#### GENERAL

Series: Dau  
Subseries: Dau Single  
Brand: Milan  
Division: Design  
Mounting Type: Track  
Mounting Location: Ceiling  
Subcategory: Spots

#### PHYSICAL

Shape: Cube  
Width (mm): 80  
Width (in): 3 1/8  
Height (mm): 165  
Height (in): 6 1/2  
Light Distribution: Adjustable / Direct  
Fixture Finish: BAL / MWL / BSL  
Fixture Material: Extruded Aluminum

#### ELECTRICAL

Number of Lamps: 1  
Lamp Type: LED  
Total Output Wattage (W): 9.3  
Dimming: Phase Dimming (120Vac Only)  
Input Voltage (V): 120

#### LED

Number of LEDs: 1  
Color Temperature (°K): 3000  
Max. Delivered Lumen (lm): 956  
CRI: >90 CRI  
Lamp Life (hrs): 50000

#### OPTICAL

#### RATINGS AND CERTIFICATIONS

Certified By: Certified for North American Standards  
IP rating: IP20

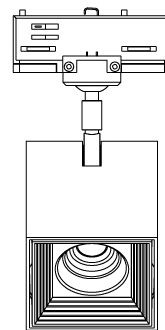
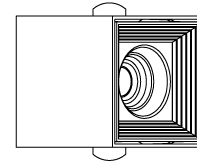

80mm 3 1/8"

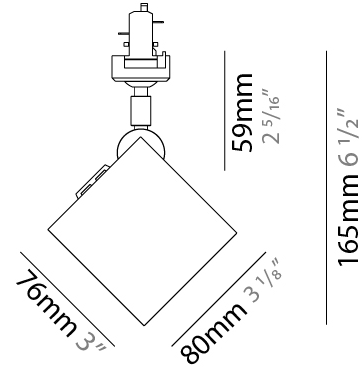

## DAU SINGLE TRACK

D96048R9-

PROJECT \_\_\_\_\_

TYPE \_\_\_\_\_

SPECIFIER \_\_\_\_\_

QUANTITY \_\_\_\_\_

DATE \_\_\_\_\_

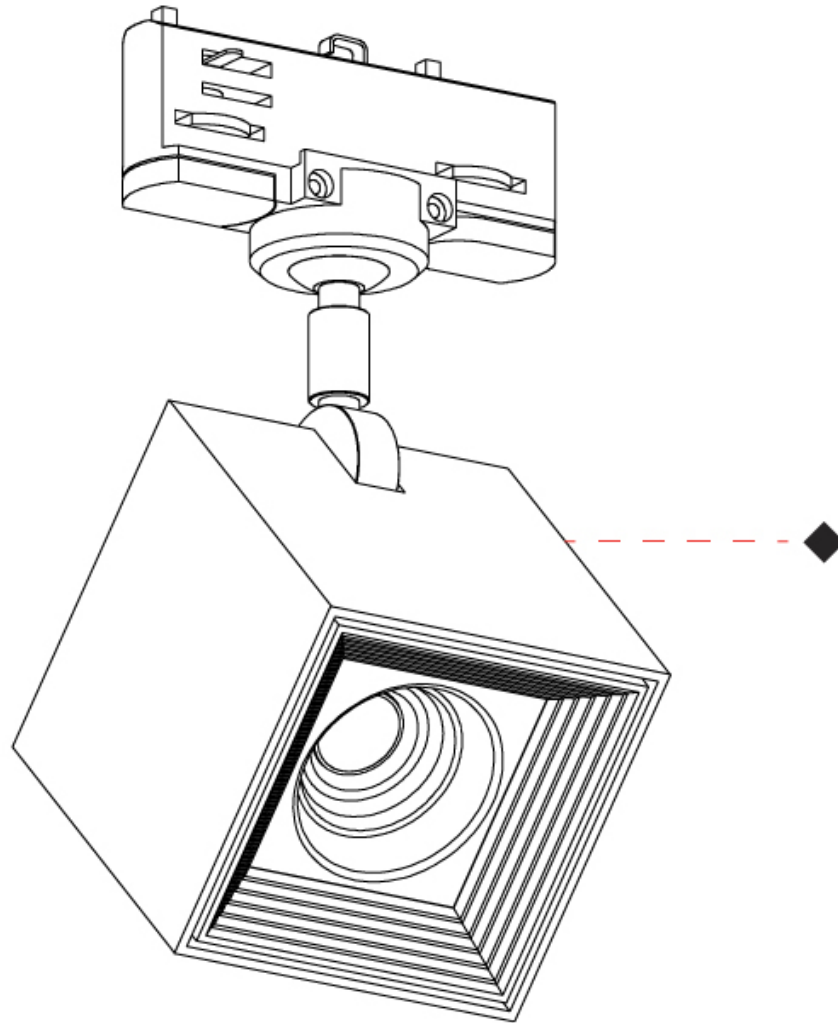

D

## DAU SINGLE TRACK

### D96052-

base number            Finish             
Options           

1. To build a product code in our configurator select the specify button on the base model # product page
2. To build a manual product code on this datasheet choose from the options listed below in blue font and add the suffix to the base model #

#### GENERAL

Series: Dau             
Subseries: Dau Single             
Brand: Milan             
Division: Design             
Mounting Type: Track             
Mounting Location: Ceiling             
Subcategory: Spots           

#### PHYSICAL

Shape: Cube             
Width (mm): 80             
Width (in): 3 <sup>1</sup>/<sub>8</sub>             
Height (mm): 162             
Height (in): 6 <sup>3</sup>/<sub>8</sub>             
Light Distribution: Adjustable / Direct             
Fixture Finish: [BAL](#) / [MWL](#) / [BSL](#)             
Fixture Material: Extruded Aluminum           

#### ELECTRICAL

Number of Lamps: 1             
Lamp Type: LED Retrofit             
Bulb Included: Bulb Not Included             
Max. Wattage Per Lamp (W): 8             
Lamp Base: GU10             
Driver Included: No             
Input Voltage (V): 120           

#### LED

#### OPTICAL

#### RATINGS AND CERTIFICATIONS

Certified By: Certified for North American Standards             
IP rating: IP20           



PROJECT

TYPE

SPECIFIER

QUANTITY

DATE

#### Fixture Finish

Brushed Aluminum - BAL



Matte White Lacquer - MWL



Black Satin Aluminum - BSL

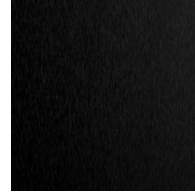

**Digital:** Not all screens are calibrated the same, and therefore, colors will appear differently between screens.











**Physical:** When texture is involved, there will be variations in color, character and tone within a product series and between product families.



### LEGEND

	floor-mounted		pivotal		special LED (upon request) RGB, RGBW, tunable, gold+, meat+, art+, fashion+
	wall and ceiling: recessed and surface mounted		rotating		warm dim / natural dimming LED
	ceiling-mounted and wall-mounted		illuminate tilted		rechargeable battery powered
	wall-mounted		color of suspension cable		fixture with natural vivid LED (upon request)
	omni-directional light distribution		length of suspension cable		color rendering index
	direct light distribution		reflector degree selection		color temperature
	direct/indirect light distribution		super spot		lumen (luminous flux)
	indirect light distribution		lens		efficacy (lumens per watt)
	asymmetric light distribution		lens pack		Unified Glare Rating (UGR) range from 5-40
	aura light distribution		shine ring		marine grade (AISI 316 stainless steel)
	round wall or ceiling cut-out		integrated shine ring with diffuser		walk on
	square wall or ceiling cut-out		free individual colors 01-29		drive on
	the supplied jig specifies the cutout dimensions		individual colors: 00 (free of charge), 01-25 (extra charge)		Dark Sky Compliance
	minimum distance (meters) lamp - object		luminaire part to be colored (F1)		Americans with Disabilities Act (less than 4" off the wall located between 27"-84" from floor)
	recessed depth		luminaire part to be colored (F2)		lamp protected against explosion
	ceiling thickness in mm		luminaire part to be colored (F3)		blown glass using traditional methods by master glass blower
	ceiling thickness selection		luminaire part to be colored (F4)		acoustic material
	dimmable DP (phase), DV (0-10V), DD (dali), DS (step-dim)		luminaire part to be colored (F5)		protection class I, protection insulation
	included or excluded LED driver/transformer/control gear		color of 3-circuit adaptor		protection class II, protection insulation
	separately switchable		indirect diffuser		ETL Certified to UL and CSA Standards
	sensor		direct diffuser		UL Certified to UL and CSA Standards
	remote control		ball-proof (upon request)		CSA Certified to UL and CSA Standards
	available upon request		accessory		Certified for North American Standards

### IP RATING

	protected against ingress of solid bodies greater than 12.5mm (finger)
	protected against ingress of solid bodies greater than 2.5mm protected against sprays of water up to 60 degrees from the vertical (rain)
	protected against ingress of solid bodies greater than 1mm (wire) no protection against the ingress of moisture
	protected against ingress of solid bodies greater than 1mm (wire) protected against sprays of water up to 60 degrees from the vertical (rain)
	protected against ingress of solid bodies greater than 1mm (wire) protected against water splashed from all directions
	protected against limited ingress of dust (wet rooms/covered outdoor areas) protected against water splashed from all directions
	protected against ingress of dust protected against jets of water
	protected against ingress of dust protected against powerful jets of water or heavy seas
	protected against ingress of dust protected against immersion of water between 15cm - 1m for 30 minutes
	protected against ingress of dust protected against immersion of water under pressure for long periods

### IK RATING

	protected against 0.14 joules impact (equivalent to 0.25kg mass dropped from 56mm above the surface)
	protected against 0.2 joules impact (equivalent to 0.25kg mass dropped from 80mm above the surface)
	protected against 0.35 joules impact (equivalent to 0.25kg mass dropped from 140mm above the surface)
	protected against 0.5 joules impact (equivalent to 0.25kg mass dropped from 200mm above the surface)
	protected against 0.7 joules impact (equivalent to 0.25kg mass dropped from 280mm above the surface)
	protected against 1 joules impact (equivalent to 0.25kg mass dropped from 400mm above the surface)
	protected against 2 joules impact (equivalent to 0.5kg mass dropped from 400mm above the surface)
	protected against 5 joules impact (equivalent to 1.7kg mass dropped from 300mm above the surface)
	protected against 10 joules impact (equivalent to 5.0kg mass dropped from 200mm above the surface)
	protected against 20 joules impact (equivalent to 5.0kg mass dropped from 400mm above the surface)